

CONTENTS

OF YOUR OWNER'S MANUAL

CONTENTS

Introduction	1
• Welcome	1
• Features	1
• Included in Your Package	2
Installing and Adjusting Your Phone	3
• Desk/Tabletop Installation	3
• Wall Installation	4
• Installing the Handset Battery Pack	9
• Charging the Battery Pack	10
• Cleaning the Battery Contacts	11
• Page	11
• Setting the Pulse/Tone Switch	12
• Adjusting the Ringer Controls	12
• Changing the Handset Ringer	12
• Installing the Beltclip	13
• Headset Installation	14
• Automatic Digital Code Security	14
Using Your New Phone	15
• Making and Receiving Calls	15
• Flash and Call Waiting	15
• Adjusting Volume During a Call	16
• Storing a Phone Number in Memory	16
• Dialing with Memory Features	16
• Chain Dialing	17
• Mute	17
• Traveling Out-of-Range	17
• Erasing a Stored Number from Memory	17
• Redial	18
• Tone	18
Troubleshooting	19
• Quick Reference Chart	19
Specifications	21

Fold out the back cover of this owner's manual to use the handy "Controls and Functions" page for reference.

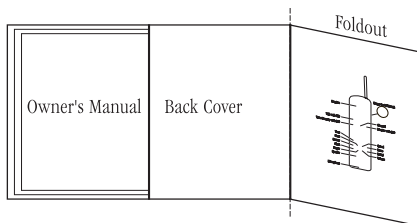

INTRODUCTION

TO YOUR NEW PHONE

WELCOME

Congratulations on your purchase of the Uniden EXS9110 cordless telephone. This phone is designed for reliability, long life, and outstanding performance utilizing the latest in 900 MHz Spread Spectrum technology.

FEATURES

- 900 MHz Spread Spectrum Technology
- 20 Enhanced Memory Dial Locations
- 4 One-Touch Memory Locations
- 32 Digit Redial
- 2nd Battery Capability
- Back-up Power Supply with Optional Battery Pack
- Redial, Flash, and Pause
- Pulse/Tone Dialing
- Page
- 7 Day Standby Battery Time
- 4 Hour Talk Time
- Handset Earpiece and Ringer Volume Control
- Hearing Aid Compatible

Digital Spread Spectrum Technology utilizes a “wider frequency band” vs. a “single narrow band” used in standard digital transmissions. The result is a more secure conversation with the clarity of digital sound, extended range, and minimal interference from other cordless phones.

Random Code™ digital security automatically selects one of over 65,000 codes for the handset and base.

These features enhance your phone's security and also prevent unauthorized calls as a result of your phone being activated by other equipment.

TIP

To get the most from your phone, please read this owner's manual thoroughly. Also be sure to complete and mail the product registration form.

NOTE

If any of these items are missing or damaged, contact the Uniden Parts Department at (800)554-3988. Hours are from 8:00 a.m. to 5:00 p.m. Central Time, Monday through Friday. We can also be reached on the web at www.uniden.com.

NOTE

The beltclip is attached to the bottom of the base.

INCLUDED IN YOUR PACKAGE



Handset

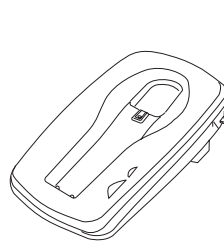

Base

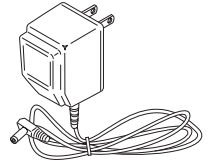

AC Adapter

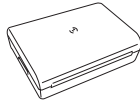

Rechargeable Battery

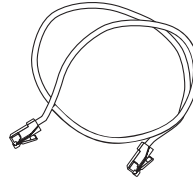

Short Telephone Cord



Beltclip

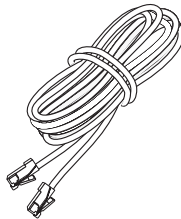

Long Telephone Cord

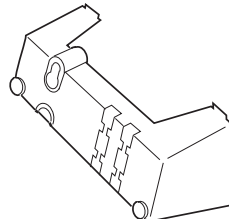

Desktop/ Wall Mount Adapter

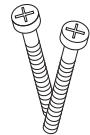

Wall Mounting Screws

- This Owner's Manual
- Precautions and Important Safety Instructions
- Registration Card

TIP

Before choosing a location for your phone, read the “Installation Considerations” included in the “Precautions and Important Safety Instructions” brochure.

DESK/TABLETOP INSTALLATION

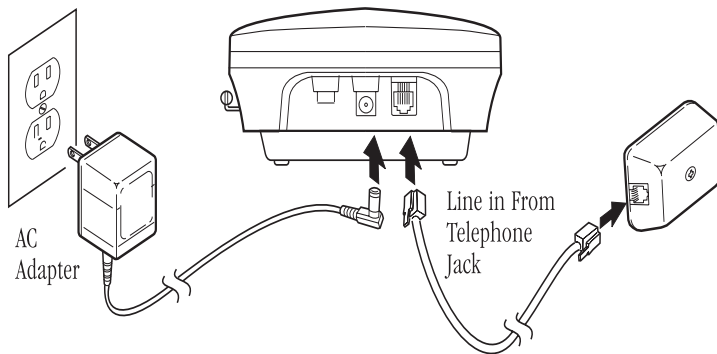

- 1) Plug the AC adapter cord into the 9 VDC input jack on the back of the base.
- 2) Wrap the AC adapter cord around the strain relief notch.



Place the power cord so that it does not create a trip hazard or where it could become chafed and create a fire or electrical hazard.

- 3) Plug the AC adapter into a standard 120 VAC wall outlet.



Use only the Uniden AC adapter supplied with this phone and DO NOT use an outlet controlled by a wall switch.

- 4) Charge the battery (refer to “Charging the Battery Pack,” page 10).
- 5) Plug one end of the long telephone cord into the **TEL LINE** jack on the back of the base.
- 6) Plug the other end of the cord into your telephone jack on the wall.

HINT

Before using your phone, fully charge the Nickel-Cadmium battery pack for 15-20 hours.

CAUTION

Place the power cord so that it does not create a trip hazard or where it could become chafed and create a fire or electrical hazard.

- 7) Attach the desktop stand to the base.

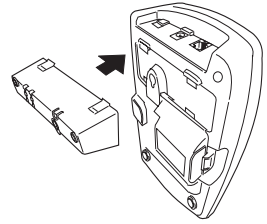

- 8) Set the base on a desk or tabletop and place the handset into the base as shown. Then, raise the antenna to a vertical position.

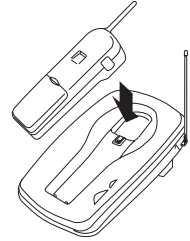

WALL INSTALLATION

▼ *Standard wall plate mounting*

This phone can be mounted on any standard AT&T or GTE wall plate.

- 1) Remove the wall mount adapter from the notches at the top of the base.

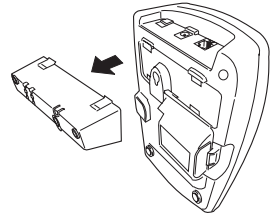

- 2) Rotate the wall mount adapter 180 degrees and snap it into place at the bottom of the base.

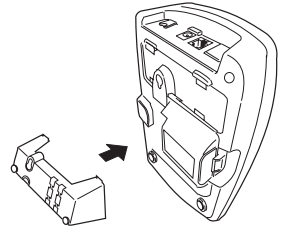



DO NOT use an outlet controlled by a wall switch.



Before you plug the other end of the telephone cord into the modular jack on the wall, charge the battery (refer to "Charging the Battery Pack," page 10).

- 4) Put the AC adapter cord inside the molded wiring channel, then wrap it around the strain relief notch. Plug the AC adapter into a standard 120 VAC wall outlet.

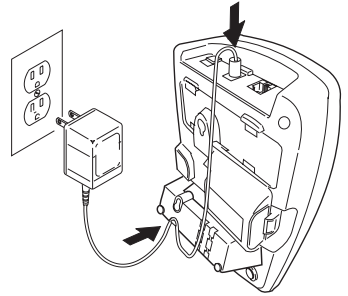

- 5) Plug one end of the short telephone cord into the **TEL LINE** jack on the back of the base, then plug the other end into a standard telephone jack.

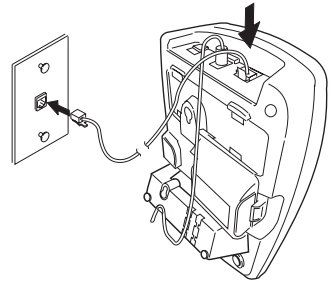

- 6) Line up the mounting slots on the base with the mounting posts on the wall, then push in and down until the phone is firmly seated.

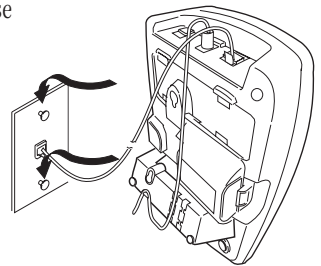

- 7) On the base unit, pull the handset retainer out of the slot and rotate it clockwise 180 degrees.

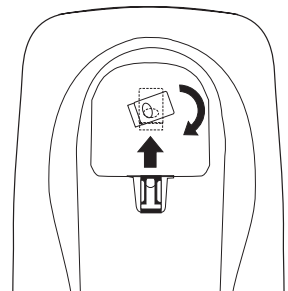

- 8) Flip the retainer from front to back, then slide it into the slot so that the lip of the retainer faces up and the oval is at the bottom of the retainer. This will hold the handset in place.

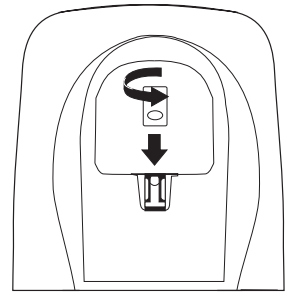

▼ *Direct wall mounting*

If you don't have a standard wall plate, you can mount your phone directly to the wall. Before doing this, consider the following:

- Select a location away from electrical cables, pipes, or other items behind the mounting location. Inserting screws into areas such as this can be hazardous.
- Try to mount your phone within 10 - 15 feet of a working phone jack in order to avoid excessive cord lengths. Remember, you are not mounting to a wall plate with a built in phone jack.
- If the selected mounting area has no wooden support beams directly behind it, you will need the appropriate anchoring devices in order for the wall to properly support your phone.

- 1) Insert two mounting screws into the wall, with their appropriate anchoring device if necessary, 3-15/16 inches apart. Allow about 3/16 of an inch between the wall and screwheads for mounting the phone.

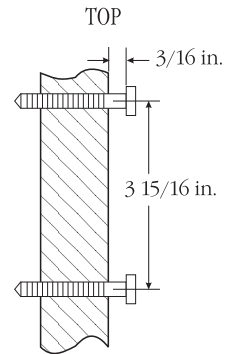

- 2) Remove the wall mount adapter from the notches at the top of the base.

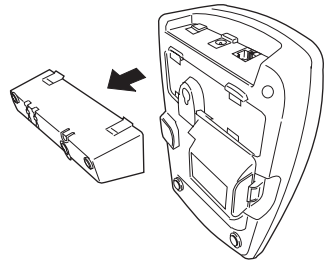

- 3) Rotate the wall mount adapter 180 degrees and snap it into place at the bottom of the base.

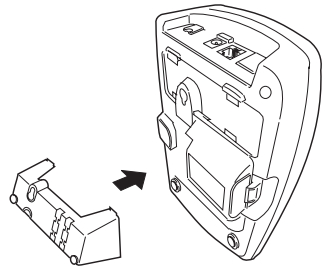

- 4) Plug the AC adapter into the base.

- 5) Put the AC adapter cord inside the molded wiring channel, then wrap it around the strain relief notch. Plug the AC adapter into a standard 120 VAC wall outlet.

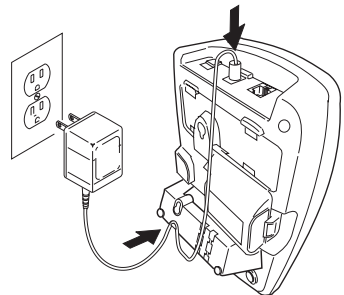

- 6) Plug one end of the long telephone cord into the **TEL LINE** jack on the back of the base, then plug the other end into a standard telephone jack.

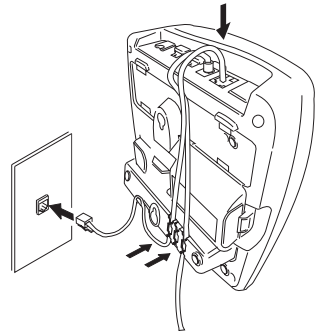

- 7) Line up the mounting slots on the base with the mounting screws on the wall, then push in and down until the phone is firmly seated.

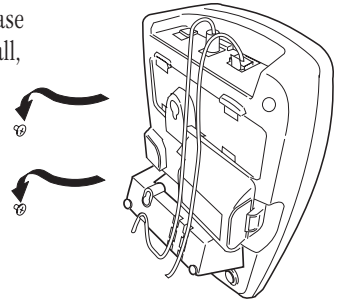

- 8) On the base unit, pull the handset retainer out of the slot and rotate it clockwise 180 degrees.

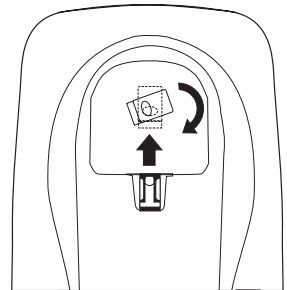

- 9) Flip the retainer from front to back, then slide it into the slot so that the lip of the retainer faces up and the oval is at the bottom of the retainer. This will hold the handset in place.

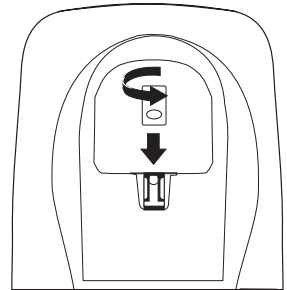

INSTALLING THE HANDSET BATTERY PACK

- 1) Press in on the battery cover release and slide the cover down until it comes off.

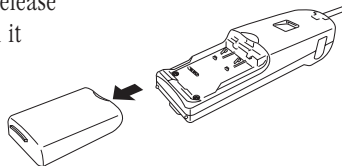

- 2) Install the nickel-cadmium battery with the label facing down.

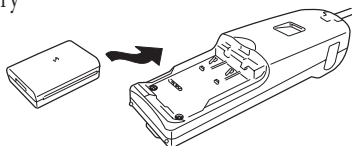

- 3) Slide the battery cover on until it snaps into place.

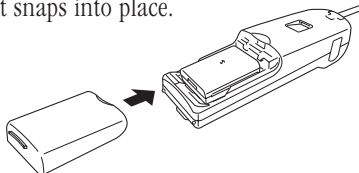

Use only Uniden battery model (BT-990) supplied with your phone.

CHARGING THE BATTERY PACK

▼ *Initial battery charging*

Before plugging the phone line into your new phone for the first time, fully charge the rechargeable battery pack for 15-20 hours *without interruption*.

- 1) Place the handset on the base.
- 2) Make sure that **status** LED lights. If the LED doesn't light, check to see that the AC adapter is plugged in and that the handset makes good contact with the base charging contacts.

▼ *Charging optional battery packs*

The base unit of your phone is equipped with a compartment for charging an extra battery pack for use in your handset. **You can obtain an extra battery pack from your authorized Uniden dealer.**

- 1) Position the battery pack so the inner side with contacts is facing up.
- 2) Slide the battery pack into the charging compartment until it clicks into place. The compartment has a latch that keeps the battery in place.

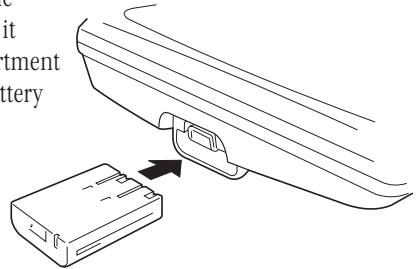

- 3) Fully charge the battery for 15-20 hours. When charging is complete, pull up on the latch to remove the battery pack. To install the charged battery into the handset, refer to "Installing the Handset Battery Pack," page 9.



In the event of a power failure, your spare battery pack can be used as a back-up power supply for the base unit.



Please visit your authorized Uniden dealer to obtain an extra battery pack or contact the Uniden parts department at (800)554-3988. Hours are from 8:00 a.m. to 5:00 p.m. Central Time, Monday through Friday.

▼ *Low battery indicator*

The low battery indicator shows when the battery needs to be re-charged. If the phone is not in use, the **talk/batt low** LED flashes every three seconds. If the phone is in use, the **talk/batt low** LED flashes every three seconds and the handset beeps. Complete your conversation as quickly as possible and return the handset to the base for charging.

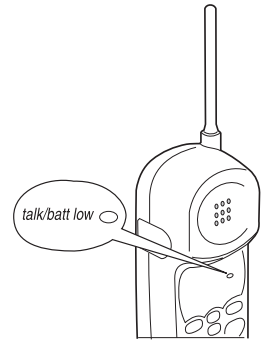

CLEANING THE BATTERY CONTACTS

To maintain a good charge, clean all charging contacts on the handset and base about once a month with a pencil eraser or other contact cleaner. DO NOT use liquids or solvents; you may damage your phone.

PAGE

To locate the handset (while it's off the base), press **page** on the base. The handset beeps for about 15 seconds.

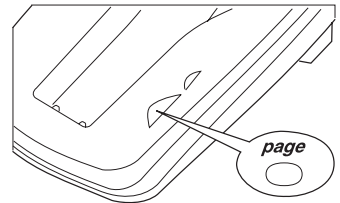

TIP

Most phone systems use tone dialing. Check with your local phone company if you're not sure whether your system is tone or pulse.

SETTING THE PULSE/TONE SWITCH

Be sure the **PULSE/TONE** switch is in the **TONE** position unless your local phone system uses pulse dialing.

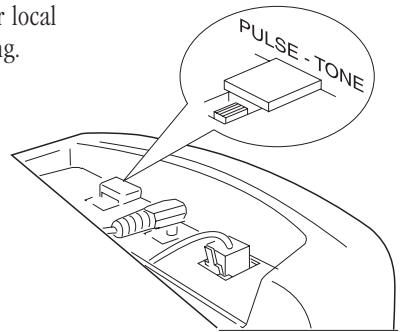

ADJUSTING THE RINGER CONTROLS

▼ *Handset ringer volume*

When the phone is either charging or in standby mode, pressing the **vol ▲** or **▼** key on the handset selects the handset ringer volume. There are two ringer volume settings; high and low.

▼ *Handset earpiece volume*

There are four volume settings for the handset earpiece; high, normal, medium, and low. The handset earpiece volume can only be adjusted during a call. To lower the volume, press **vol ▼**. To raise the volume, press **vol ▲**.

CHANGING THE HANDSET RINGER

1. Press **flash**. LED flashes.
2. Press **1**, **2**, **3** or **4** on the keypad to select ringer tone.

INSTALLING THE BELTCLIP

▼ To attach the beltclip

- 1) Remove the slot cover.

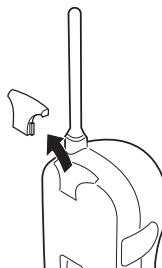

- 2) Put the beltclip in the slot and press down until it clicks.

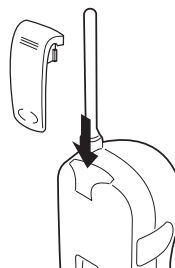

▼ To remove the beltclip

- 1) Pull back on the release tab and pull the beltclip up.

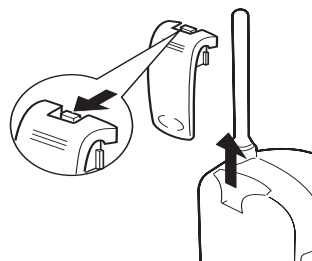

- 2) Replace the slot cover. You can store either the beltclip or slot cover on the bottom of the base.

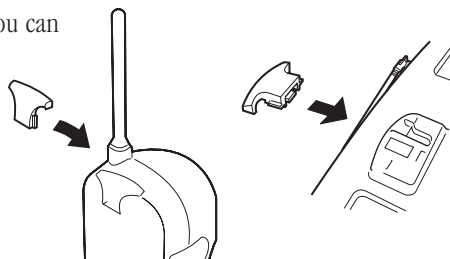

IMPORTANT

Use only the Uniden HS910 headset specifically designed for Spread Spectrum phones. You will hear a buzz or hum on other headsets.

IMPORTANT

Keep headset wire away from base antenna.

NOTE

If you are using an optional headset, you must still use the handset keypad for phone operations.

HEADSET INSTALLATION

Your phone may be used with an optional headset, the Uniden HS 910. To use this feature, simply insert the headset plug into the headset jack. Your headset is ready for hands-free conversations.

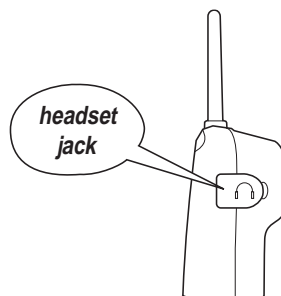



AUTOMATIC DIGITAL CODE SECURITY

To prevent other parties from making unauthorized calls on your phone line, a digital code was added to the EXS9110. Your phone's handset and base share this code, which is randomly set each time you place the handset in the charging cradle.

▼ *To reestablish communication between the handset and the base in the event of a power failure*

- 1) Restore power to the base
- 2) Place the handset on the base. The **status** LED blinks to indicate that the digital security code is reset.

MAKING AND RECEIVING CALLS

	Handset On Base 	Handset Off Base 
To answer a call	Pick up the handset.	Press any button.
To make a call	<ol style="list-style-type: none"> 1) Pick up the handset. 2) Press talk. 3) Listen for the dial tone. 4) Dial the number. 	<ol style="list-style-type: none"> 1) Press talk. 2) Listen for dial the tone. 3) Dial the number.
To hang up	Press talk , or return the handset to the base (AutoStandby).	
To redial	<ol style="list-style-type: none"> 1) Pick up the handset. 2) Press talk. 3) Listen for the dial tone. 4) Press redial. 	<ol style="list-style-type: none"> 1) Press talk. 2) Listen for the dial tone. 3) Press redial.

FLASH AND CALL WAITING

If you have “call waiting” service and a call waiting tone sounds while you are on a call, press **flash** to accept the waiting call. There is a short pause, then you will hear the new caller. To return to the original caller, press **flash** again.

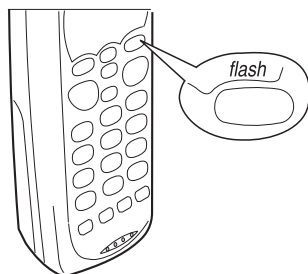

NOTE

The pause button counts as one digit. Pressing **redial/p** on the handset, more than once increases the length of pause between numbers.

NOTE

Accidentally pressing memory keys **a**, **b**, **c** or **d** may result in unintentional dialing.

ADJUSTING VOLUME DURING A CALL

Press the **vol** ▲ or ▼ key on the handset to increase or decrease volume while on a call. Volume will return to preset level when you hang up.

STORING A PHONE NUMBER IN MEMORY

- 1) Remove the handset from the base.
- 2) Press **mem** and the **talk/batt low** LED blinks.
- 3) Enter the phone number, up to 16 digits. If a pause is needed during dialing to access a long distance service, press **redial/p**.
- 4) Press **mem** again.
- 5) Enter the memory location (01-20) on the keypad or press memory key **a**, **b**, **c** or **d**. A tone indicates that the number is stored.

DIALING WITH MEMORY FEATURES

▼ Using the memory location features

- 1) Press **talk**.
- 2) Press **mem**.
- 3) Enter the memory location (01-20) on the keypad. The number automatically dials.

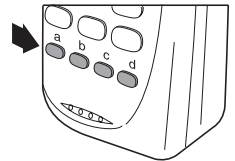

▼ One-touch memory dialing

Press a one-touch memory key **a**, **b**, **c** or **d**. The number automatically dials.

CHAIN DIALING

On certain occasions after dialing a number, you may be requested to enter an access code, such as your account number. You can enter this number into a memory location for later use by doing the following.

- 1) Store the access code into one of the memory locations (01-20) or press memory key **a**, **b**, **c** or **d** following steps 1-5 above.
- 2) Dial the party or service main number.
- 3) When you need to enter the special number, press **mem** followed by the memory location (01-20) or press memory key **a**, **b**, **c** or **d**.

MUTE

To use the mute feature during a conversation, press **mute**. The other party will not be able to hear you although you can hear them. To disable the mute feature, press **mute** again.

TRAVELING OUT-OF-RANGE

As you begin to move too far from your base unit, you will first hear a clicking sound. As you travel further out-of-range, the voice transmission will begin to break up. If you pass the range limits of the base unit, your call will terminate.

ERASING A STORED NUMBER FROM MEMORY

- 1) Remove the handset from the base unit.
- 2) Press the **mem** button twice.
- 3) Press the memory location (01-20) or press memory key **a**, **b**, **c**, or **d** to be erased. A tone indicates that the stored number is erased from memory.

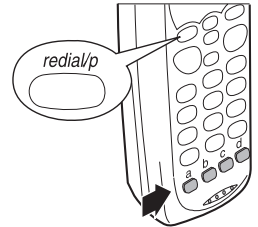

NOTE

An error sounds and the erase procedure will be canceled if more than 30 seconds elapse between each keystroke.

REDIAL

The **redial** key redials the last number dialed. The redialed number can be up to 32 digits long.

TONE

If you are dialing in the pulse mode and need to enter tone digits, press **tone** to enter the digits. Once the call has ended, the tone mode is canceled and pulse dialing resumes.

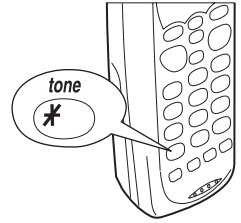

NOTE

The tone feature only applies when the base unit is set to pulse.

QUICK REFERENCE CHART

If your phone is not performing to your expectations, please try these simple steps before calling Uniden customer service.

PROBLEM	SUGGESTION
The charge light won't come on when the handset is placed in the base.	<ul style="list-style-type: none"> • Make sure the AC adapter is plugged into the base and wall outlet. • Make sure the handset is properly seated in base. • Make sure the charging contacts on the handset and base are clean.
The audio sounds weak and/or scratchy.	<ul style="list-style-type: none"> • Make sure that the base antenna is in a vertical position. • Move the handset and/or base to a different location away from metal objects or appliances and try again.
Can't make or receive calls.	<ul style="list-style-type: none"> • Check both ends of the base telephone line cord. • Make sure the AC adapter is plugged into the base and wall outlet. • Disconnect the AC adapter for a few minutes, then reconnect it. • Place the handset back on the charging cradle for a few seconds. The status LED will blink indicating that the phone has been reset.

PROBLEM	SUGGESTION
The handset doesn't ring or receive a page.	<ul style="list-style-type: none">• The Nickel-Cadmium battery pack may be weak. Charge the battery on the base unit for 15-20 hours.• The handset may be too far away from the base unit.• Place the base unit away from appliances or metal objects.• Place the handset back on the charging cradle for a few seconds. The status LED will blink indicating that the phone has been reset.

GENERAL

The EXS9110 complies with FCC Parts 15 and 68.

Frequency control: PLL

Modulation: Direct Sequence Spread Spectrum; DBPSK

Operating temperature: 0° to 50° C (+32° F to +122° F)

BASE

Frequency: 904.2 to 925.8 MHz (20 channels)

Power requirements: 9V 350 mA (from AC adapter)

Size: 5-1/2in.(W) x 3-3/4in. (D) x 10in. (H)

Weight: Approx. 17.8oz. (including optional battery)

HANDSET

Frequency: 904.2 to 925.8 MHz (20 channels)

Power requirements: Rechargeable Nickel Cadmium battery pack

Size (without antenna): 2-1/4in. (W) x 3-1/2in. (D) x 7-1/4in. (H)

Weight: Approx. 9.3oz. (including battery)

Battery: BT-990

Capacity 600 mAH, 3.6V

Talk mode 4 hours

Standby mode 7 days

Specifications, features, and availability of optional accessories are all subject to change without prior notice.

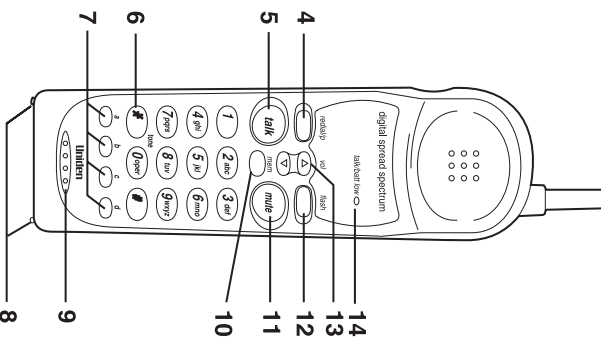
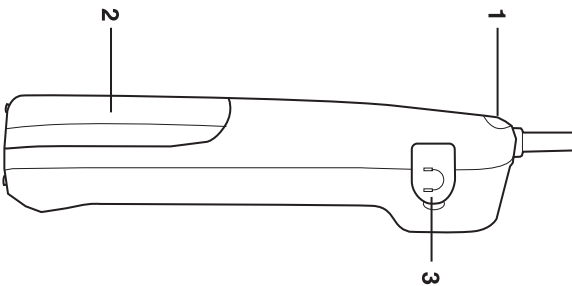

- 4. Redial/Pause
- 5. Talk
- 6. Tone
- 7. One-Touch Dialing
- 8. Charging Contacts
- 9. Handset Microphone
- 10. Mem
- 11. Mute
- 12. Flash
- 16. Handset Retainer Clip
- 17. Charging Contacts
- 18. Page
- 19. Status LED
- 20. Beltclip Holder
- 21. Desktop/Wall Mount Adaptor
- 22. Pulse/Tone
- 23. DC in 9V
- 24. Tel Line

